

PACTECH



泓格M2M解决方案



王磊

wanglei@icpdas.com.cn

Industrial Computer Product Data Acquisition System

PAC 让应用皆能达成



PAC 让应用皆能达成

关于泓格

我们是致力于发展PAC、分布式I/O控制单元、分布式I/O模块、基于PC的数据采集卡的拥有完整自动化解决方案及完善售后服务体系的泓格科技

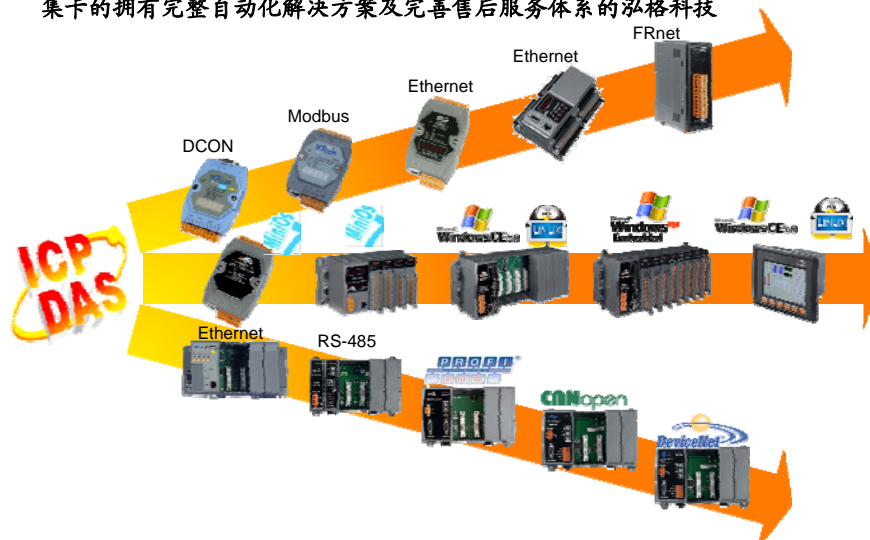

Industrial Computer Product Data Acquisition System

www.icpdas.com.cn



议程

- 什么是M2M?
- 泓格M2M解决方案
- M2M应用
- PAC与M2M
- Q&A

PACTECH



什么是M2M?



What is M2M ?

- M2M表达的是多种不同类型的通讯技术结合在一起：
机器设备之间的通讯(machine-to-machine)、机器控制通讯(machine-to-man)、人机接口通讯(man-to-machine)、移动设备与机器之间的通讯(machine-to-mobile、mobile-to-machine)
- M2M让机器、设备、应用处理过程与后端信息系统和操作用户共享讯息。

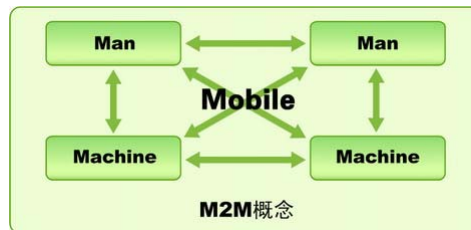

无处不在的M2M应用

M2M系统和产品具有非常广阔的发展空间。





PAC 让应用皆能达成

M2M产业链

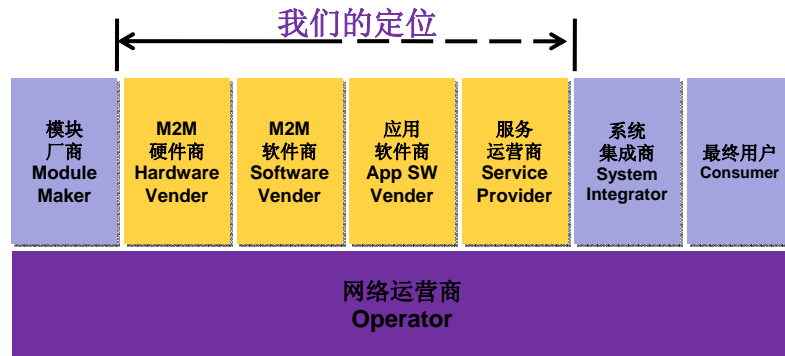

Industrial Computer Product Data Acquisition System

www.icpdas.com.cn

PACTECH



泓格M2M解决方案

Industrial Computer Product Data Acquisition System

PAC 让应用皆能达成



泓格的M2M



M2M 架构

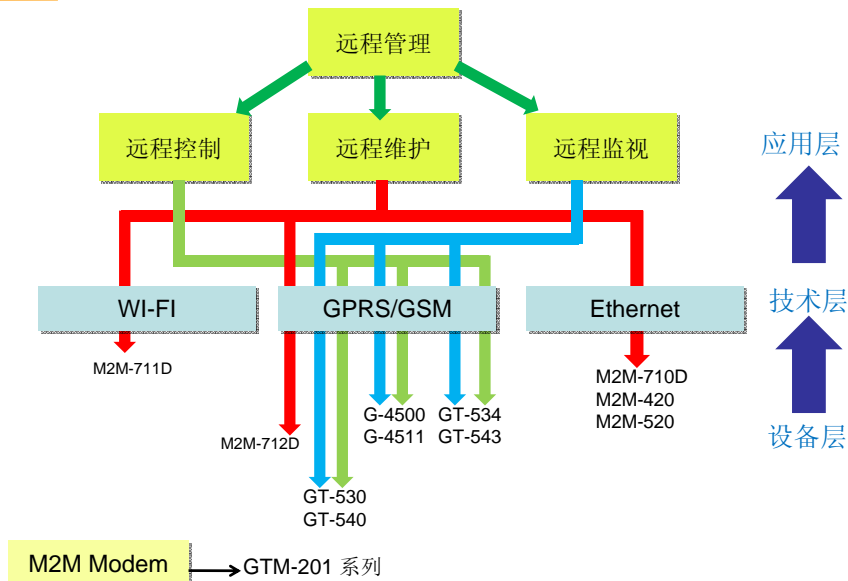



GSM/GPRS

<p>Modem (GTM-201)</p>		<ul style="list-style-type: none"> • USB, RS-232 • 数据传输 • 语音警报 	<ul style="list-style-type: none"> • 远程实时监控 • 远程资料收集 • 无人机房处理
<p>Data Server (GT-500)</p>		<ul style="list-style-type: none"> • 双向数据传输 • 数据记录 • 主动上报功能 	<ul style="list-style-type: none"> • 远程设备监控 • 家庭自动化 • 自动贩卖机 • 语音警报
<p>PAC (G-4500)</p>		<ul style="list-style-type: none"> • 提供GPRS/GSM/GPS 多样应用开发平台 • 提供客制化开发环境 	<ul style="list-style-type: none"> • 远程I/O监控 • 水文监控 • 智能车载系统



GSM/GPRS Modem

- 850/900/1800/1900 MHz
- 支持标准 AT 指令集
- MIC-in & Speaker-out
- USB 或 RS-232接口
- 导轨安装





GSM/GPRS 数据平台

- SMS智能报警终端
- GSM智能报警数据终端
- GPRS数据传输终端



ZigBee

- 转换器
 - Ethernet / RS-485 / RS-232 to ZigBee
- 中继器
- I/O模块
 - 模拟量
 - 数字量

传输距离可达
700米!





远程维护

M2M远程维护产品可混搭使用!

M2M-700D		<ul style="list-style-type: none">• 支援Web管理界面• 配对自动联机功能• 支援Wi-Fi无线传输• 同时具server/client功能
M2M-420-A		<ul style="list-style-type: none">• 支持语音传输功能• 支援Web管理界面• 同时具server/client功能
M2M-520-AV		<ul style="list-style-type: none">• 支持语音/影像传输功能• 支援VxComm技术• 同时具server/client功能



泓格M2M特色

- 现场I/O直接接入
- 环境适应性强
- 支持Modbus TCP、OPC Server
- 无缝整合Kingview、EZ Data Logger
- 可编程、可订制

PACTECH



M2M应用实例

Industrial Computer Product Data Acquisition System PAC 让应用皆能达成



PAC 让应用皆能达成

G-4500

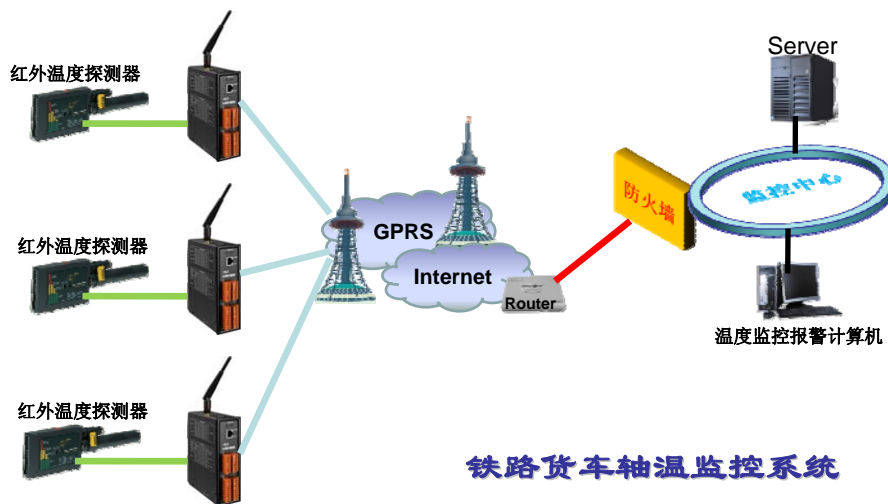

铁路货车轴温监控系统

Industrial Computer Product Data Acquisition System

www.icpdas.com.cn



PAC 让应用皆能达成

GTM-201 + μ PAC

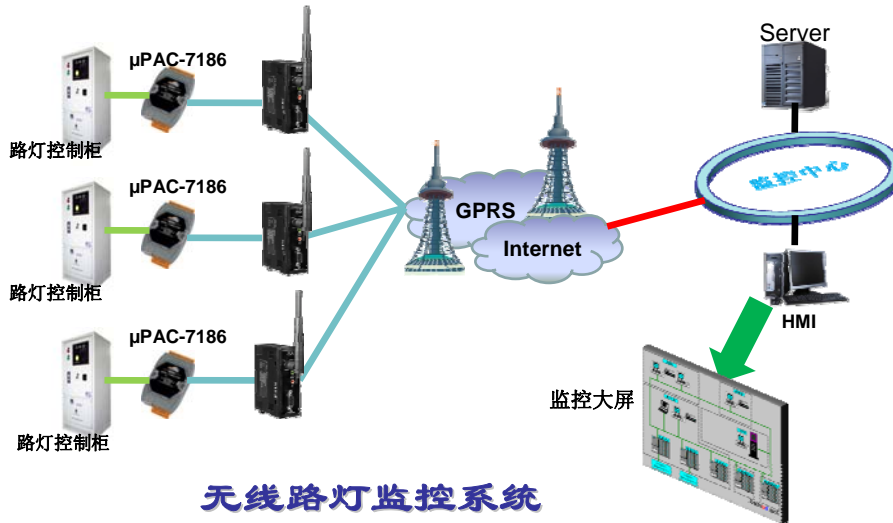

Industrial Computer Product Data Acquisition System

www.icpdas.com.cn



PAC 让应用皆能达成

GT-530



Industrial Computer Product Data Acquisition System

www.icpdas.com.cn



PAC 让应用皆能达成

PK-7340



Industrial Computer Product Data Acquisition System

www.icpdas.com.cn



PAC 让应用皆能达成

G-4500 + SSW43



水坝地震报警系统

Industrial Computer Product Data Acquisition System

www.icpdas.com.cn



PAC 让应用皆能达成

近海水文观测系统

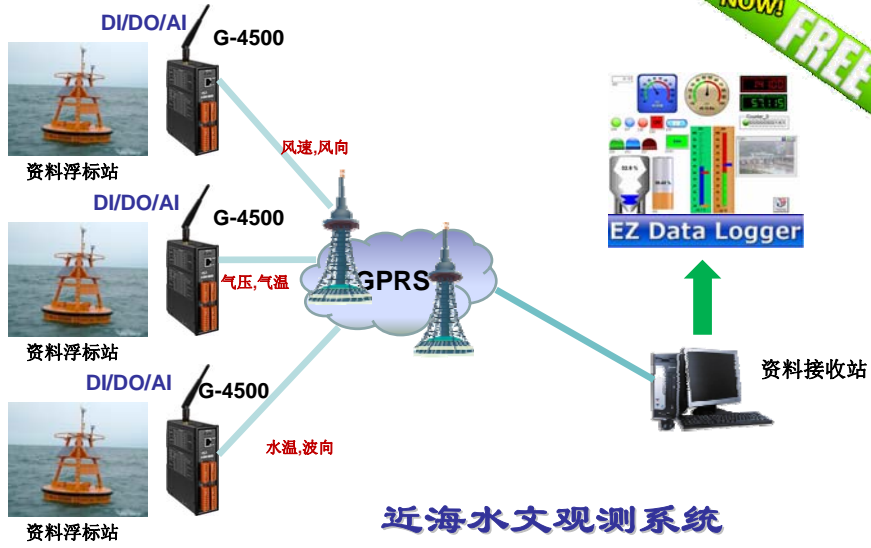

Industrial Computer Product Data Acquisition System

www.icpdas.com.cn



PAC 让应用皆能达成

ZigBee

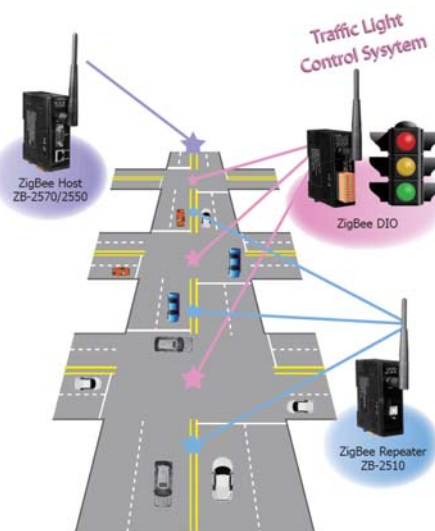

- ZB-2570
以太网/RS-485/RS-232 to ZigBee 转换器(Host)
- ZB-2571
以太网/RS-485/RS-232 to ZigBee 转换器(Slave)
- ZB-2510
ZigBee 中继器
- ZB-2060
6通道隔离数字量输入和4通道继电器输出模块

Industrial Computer Product Data Acquisition System

www.icpdas.com.cn



PAC 让应用皆能达成

远程设备维护系统

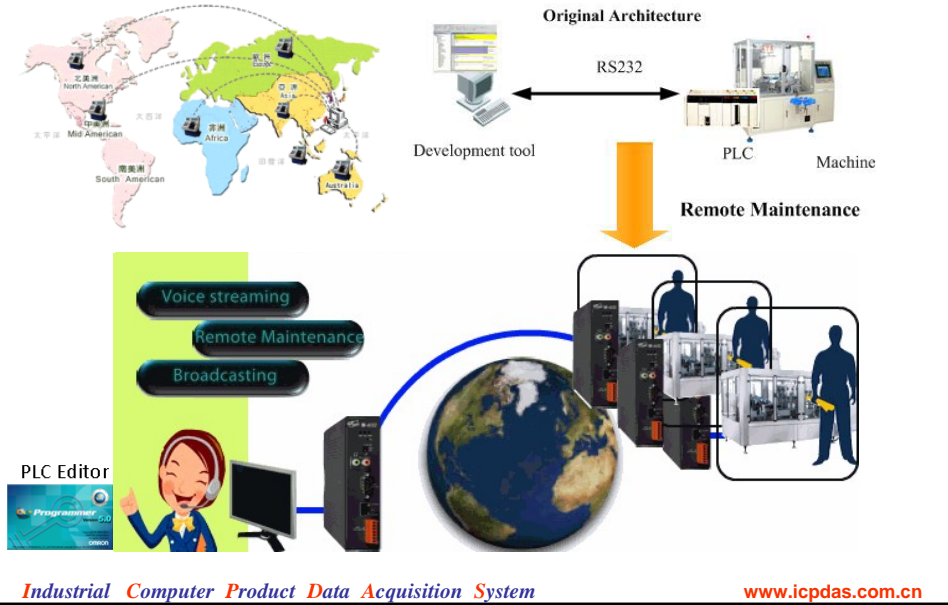

PAC 让应用皆能达成

远程设备维护系统

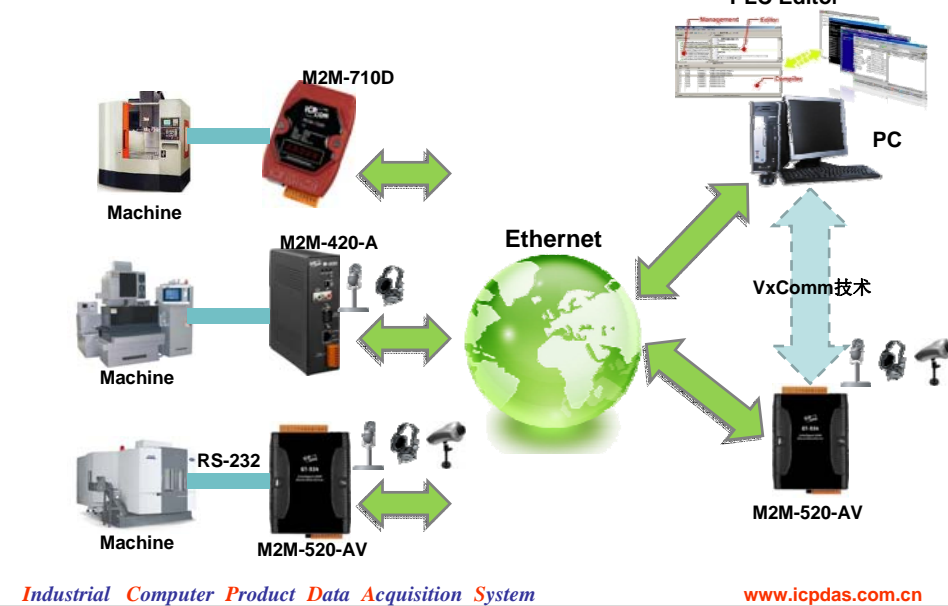



PAC 让应用皆能达成

	GSM/GPRS	ZigBee	Remote Maintenance
应用区域	广域网	个人局域网	广域网
数据传输	无线传输	无线传输	无线/有线传输
应用功能	简讯服务 语音传输 远程数据 远程IO控制	近端IO控制 近端讯号/资料撷取 携带式应用	双向语音传输 双向影像传输 远程下载程序 远程编辑程序 远程监控程序
应用场合	远程实时监控 车辆应用 机器讯息/语音自动回报 移动装置监控管理 地震预警	大楼/家庭自动化管理 工业环境控制 个人医疗照顾 交通号志管理 校园门禁管理	远距设备维护 远距字幕控制

Industrial Computer Product Data Acquisition System

www.icpdas.com.cn

PACTECH



PAC与M2M

Industrial Computer Product Data Acquisition System

PAC 让应用皆能达成



PAC 与 M2M

- I-8212W : GPS + GPRS 模块
- I-8211W : GPRS 模块



愿景

ICP DAS is an **experienced** and **trustworthy** company.





谢谢！

